

FRD Type: 20NFA40

FEATURES

- * Ultra – Fast Recovery
- * Low Forward Voltage Drop
- * Low Power Loss, High Efficiency
- * High Surge Capability
- * 400 Volts and 600 Volts Types Available

OUTLINE DRAWING

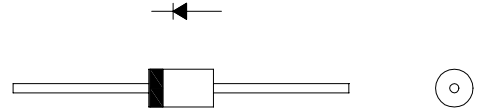

Maximum Ratings

Apporox Net Weight:1.19g

Rating	Symbol	20NFA40		Unit
Repetitive Peak Reverse Voltage	V_{RRM}	400		V
Average Rectified Output Current	I_O	2.0	$T_l=114^{\circ}C$ Tl: Lead Temperature	50HzHalf Sine Wave Resistive Load
		1.15	$T_a=25^{\circ}C$ *1	
RMS Forward Current	$I_{F(RMS)}$	3.14		A
Surge Forward Current	I_{FSM}	50	50Hz Half Sine Wave,1cycle, Non-repetitive	A
Operating JunctionTemperature Range	T_{jw}	- 40 to + 150		$^{\circ}C$
Storage Temperature Range	T_{stg}	- 40 to + 150		$^{\circ}C$

Electrical/Thermal • Characteristics

Characteristics	Symbol	Conditions	Min.	Typ.	Max.	Unit
Peak Reverse Current	I_{RM}	$T_j= 25^{\circ}C, V_{RM}= V_{RRM}$	-	-	10	μA
Peak Forward Voltage	V_{FM}	$T_j= 25^{\circ}C, I_{FM}= 2A$	-	-	1.28	V
Reverse Recovery Time	trr	$T_a= 25^{\circ}C, I_{FM}=2A -di/dt=50A/\mu s$	-	-	35	ns
Thermal Resistance	Rth(j-l)	Junction to Lead	-	-	15	$^{\circ}C/W$
	Rth(j-a)	Junction to Ambient			90	

*1: Without Fin or P.C. Board

20NFA_ OUTLINE DRAWING (Dimensions in mm)

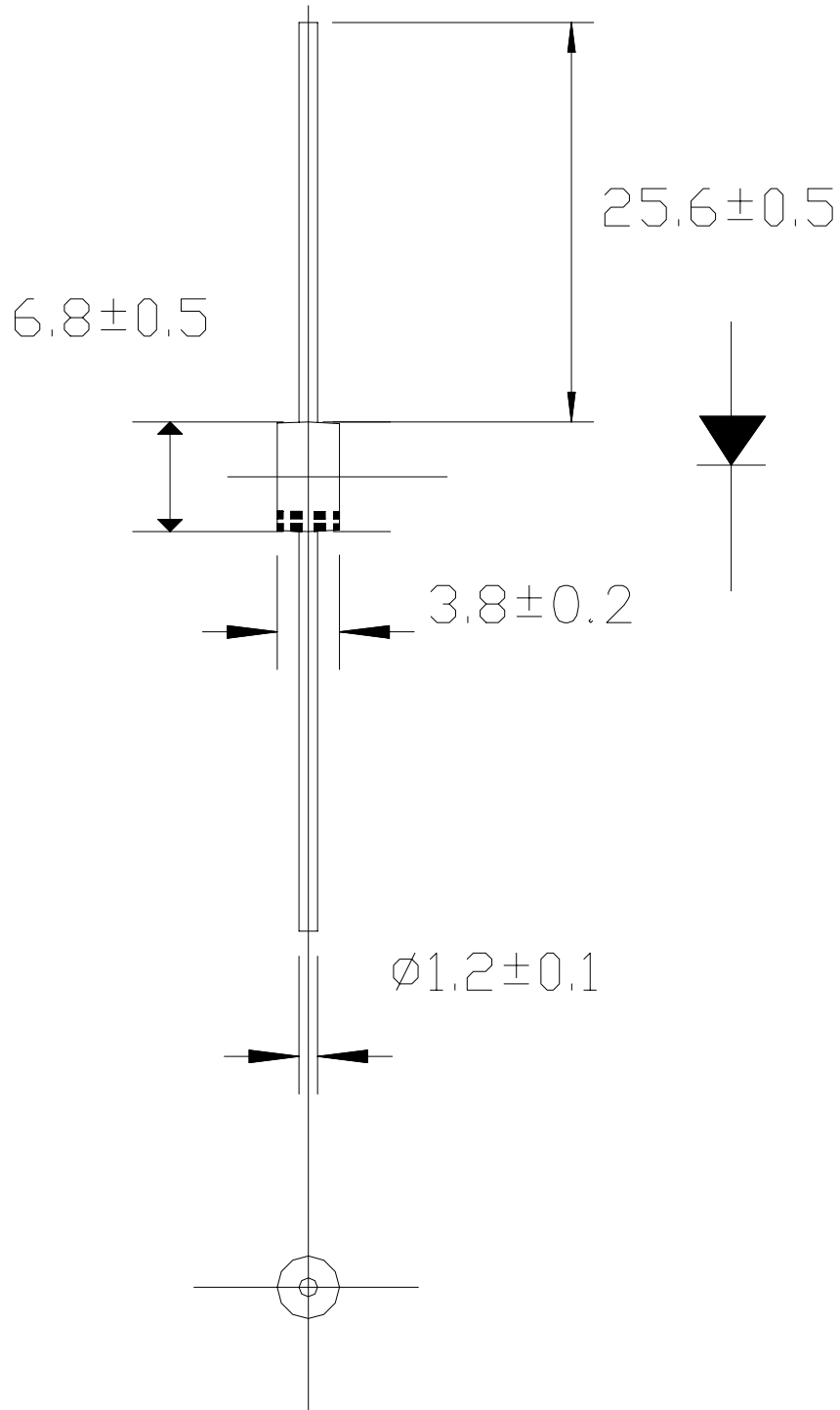

FORWARD CURRENT VS. VOLTAGE

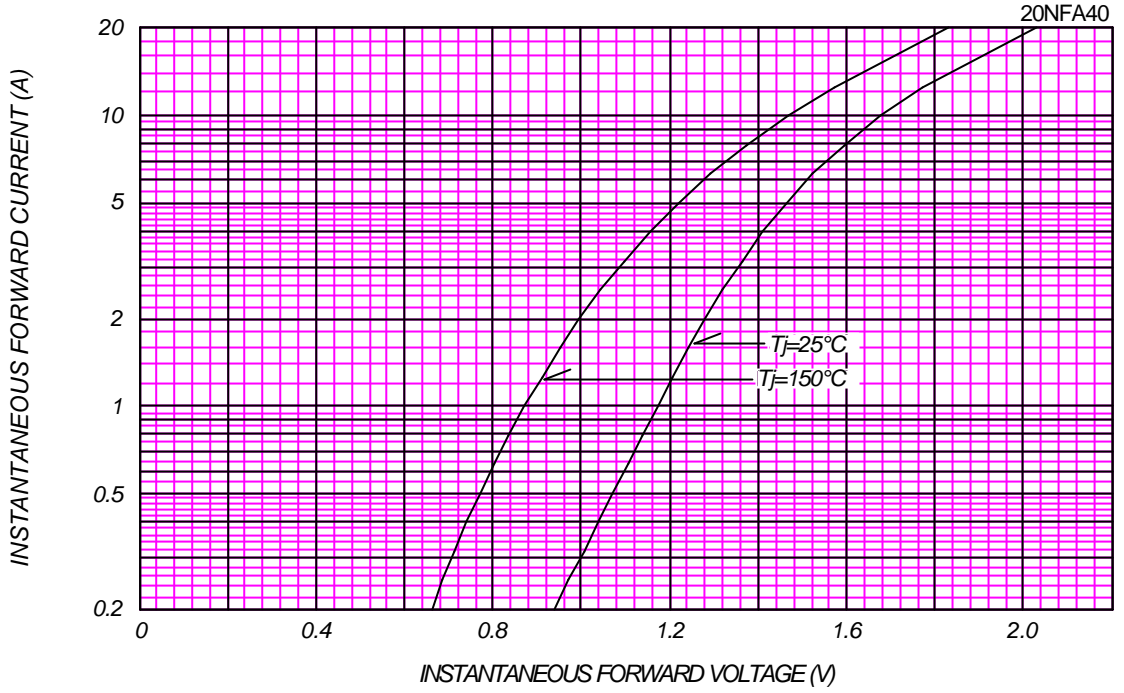

AVERAGE FORWARD POWER DISSIPATION

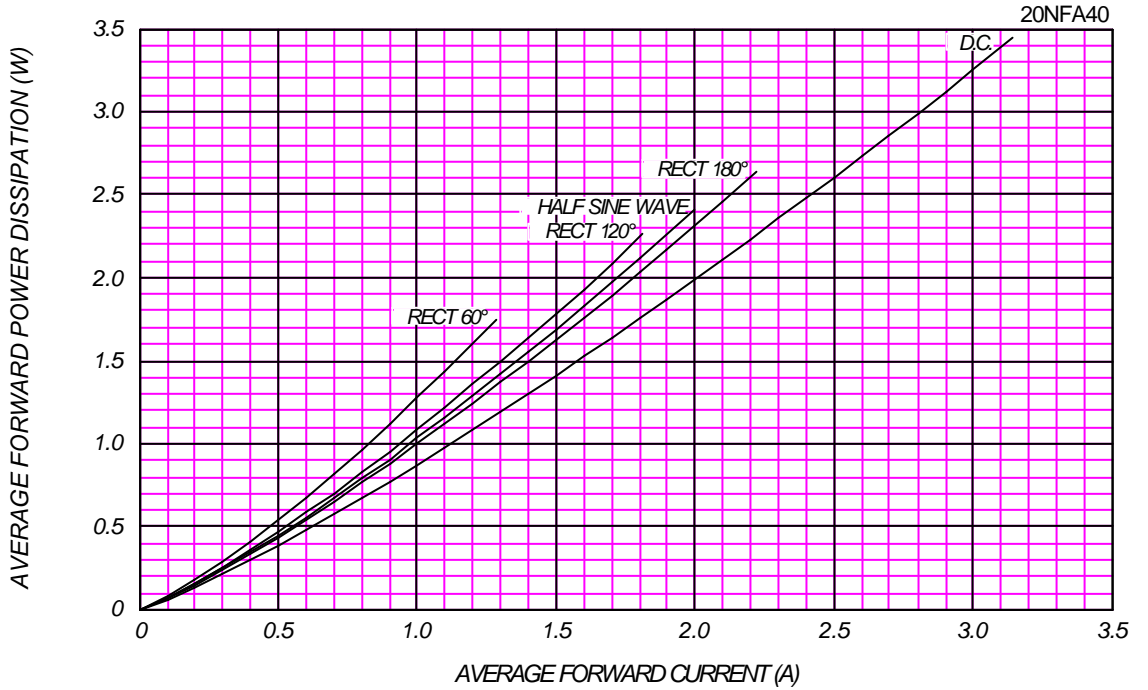



AVERAGE FORWARD CURRENT VS. AMBIENT TEMPERATURE

Without Fin or P.C.Board

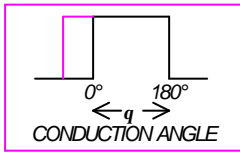
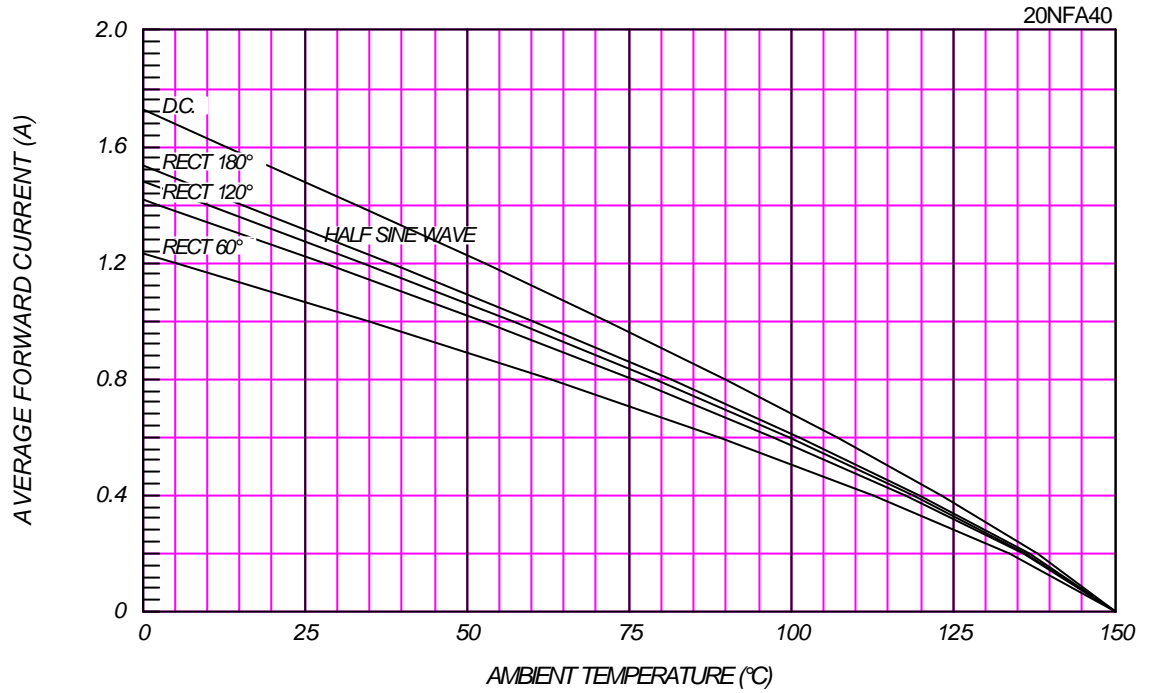

AVERAGE FORWARD CURRENT VS. LEAD TEMPERATURE

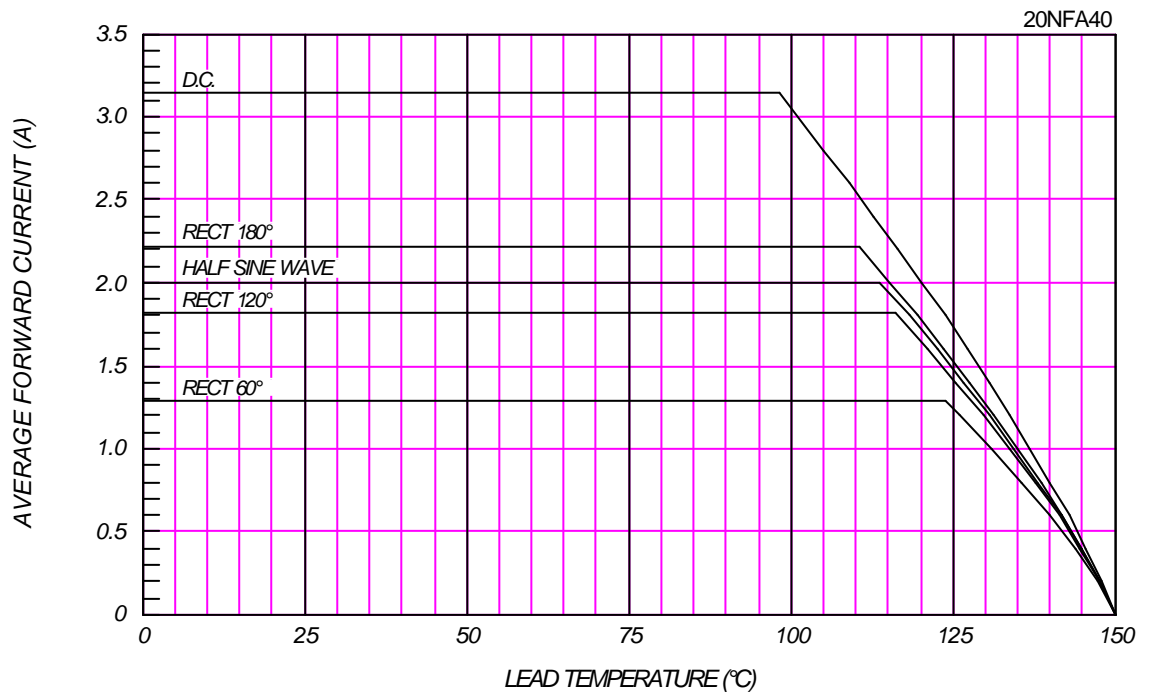

SURGE CURRENT RATINGS

f=50Hz, Half Sine Wave, Non-Repetitive, No Load

20NFA40

